

D2FL20U

Forward Voltage

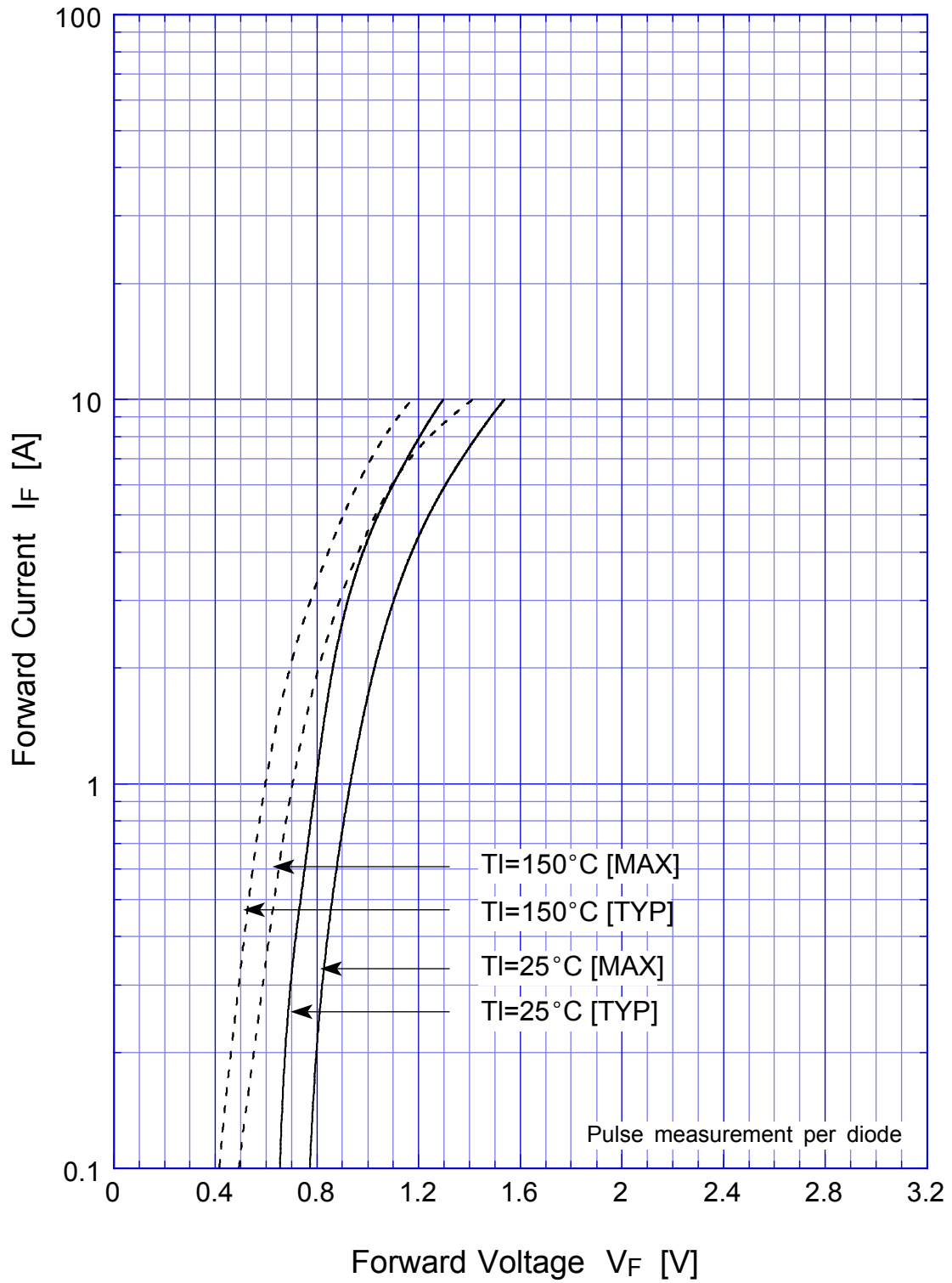

D2FL20U Forward Power Dissipation

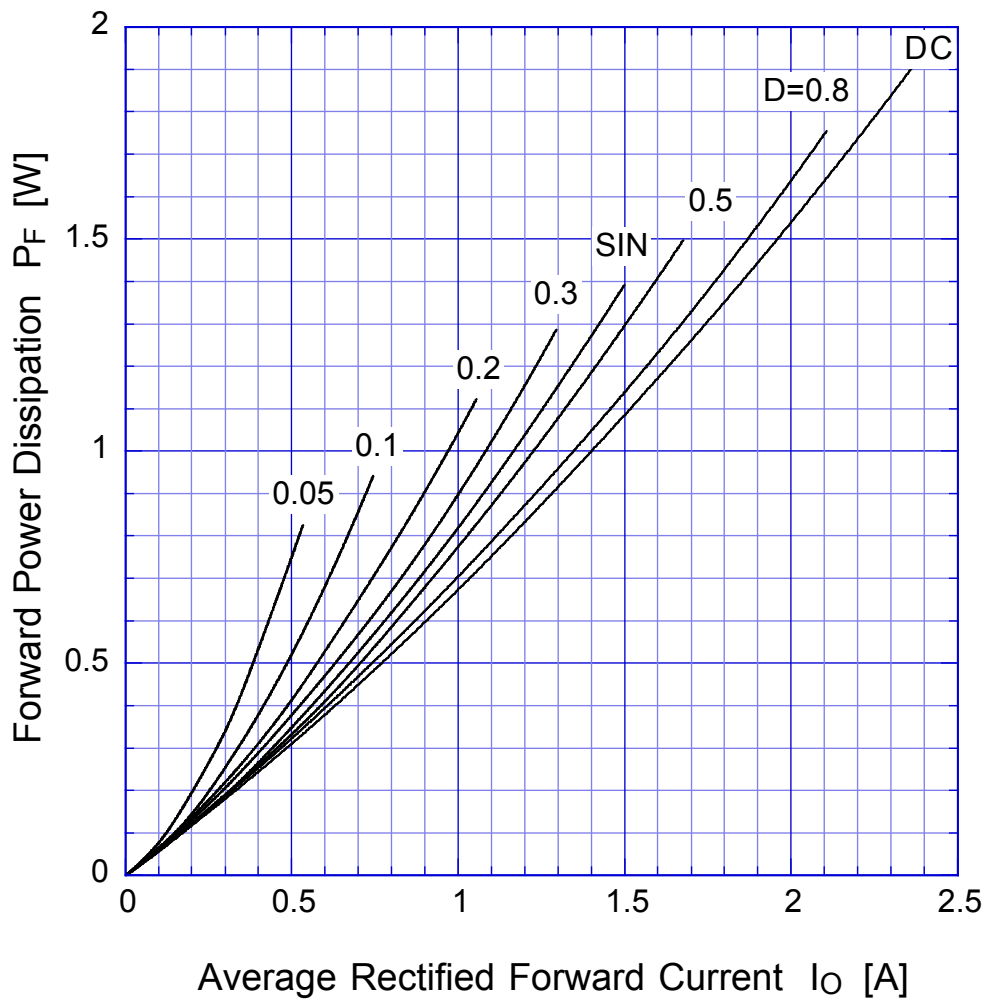

$T_j = T_{jmax}$

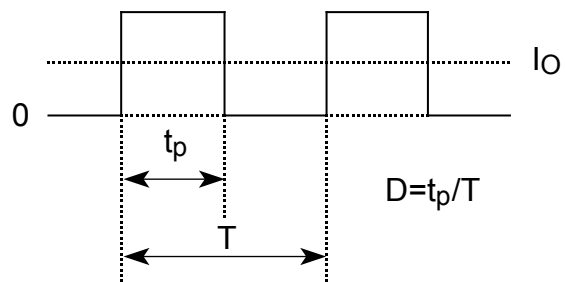

D2FL20U

Derating Curve

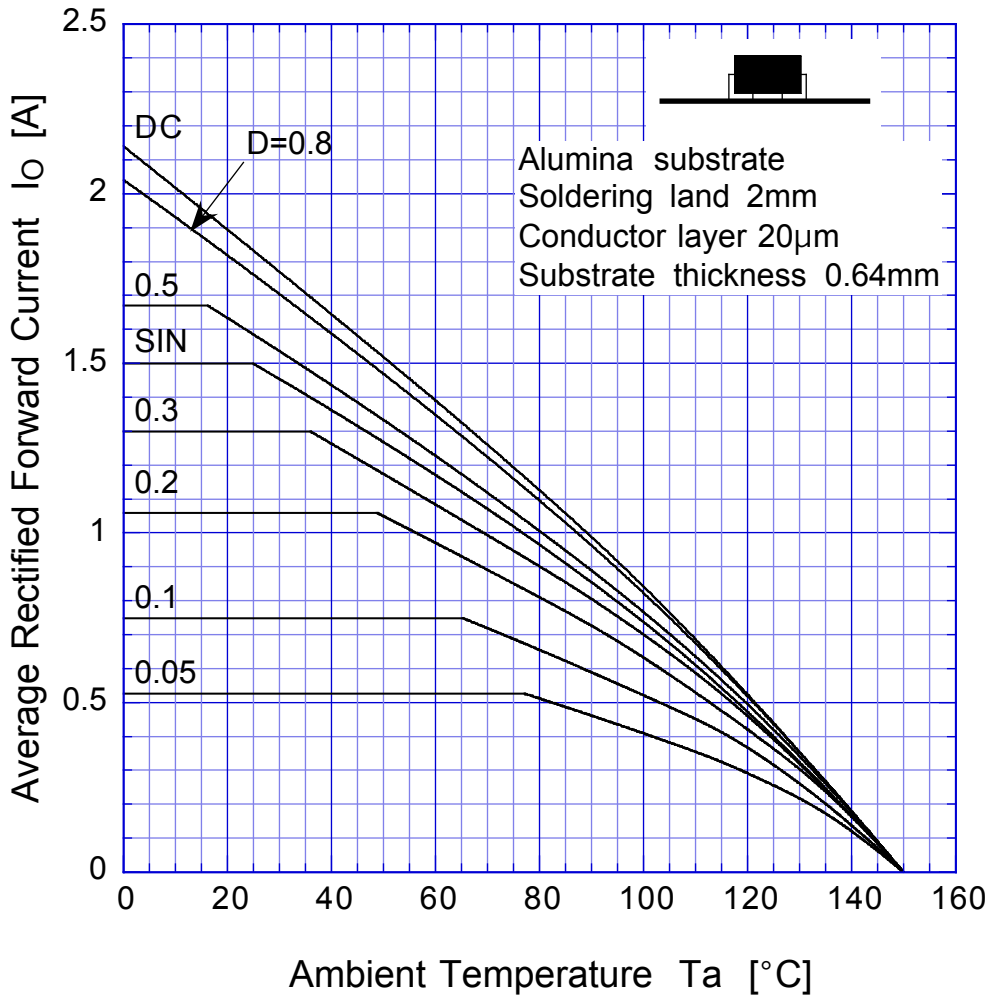

$$V_R = V_{RM}$$

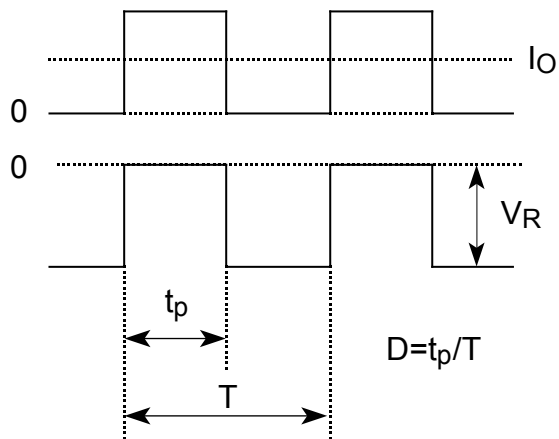

D2FL20U

Derating Curve

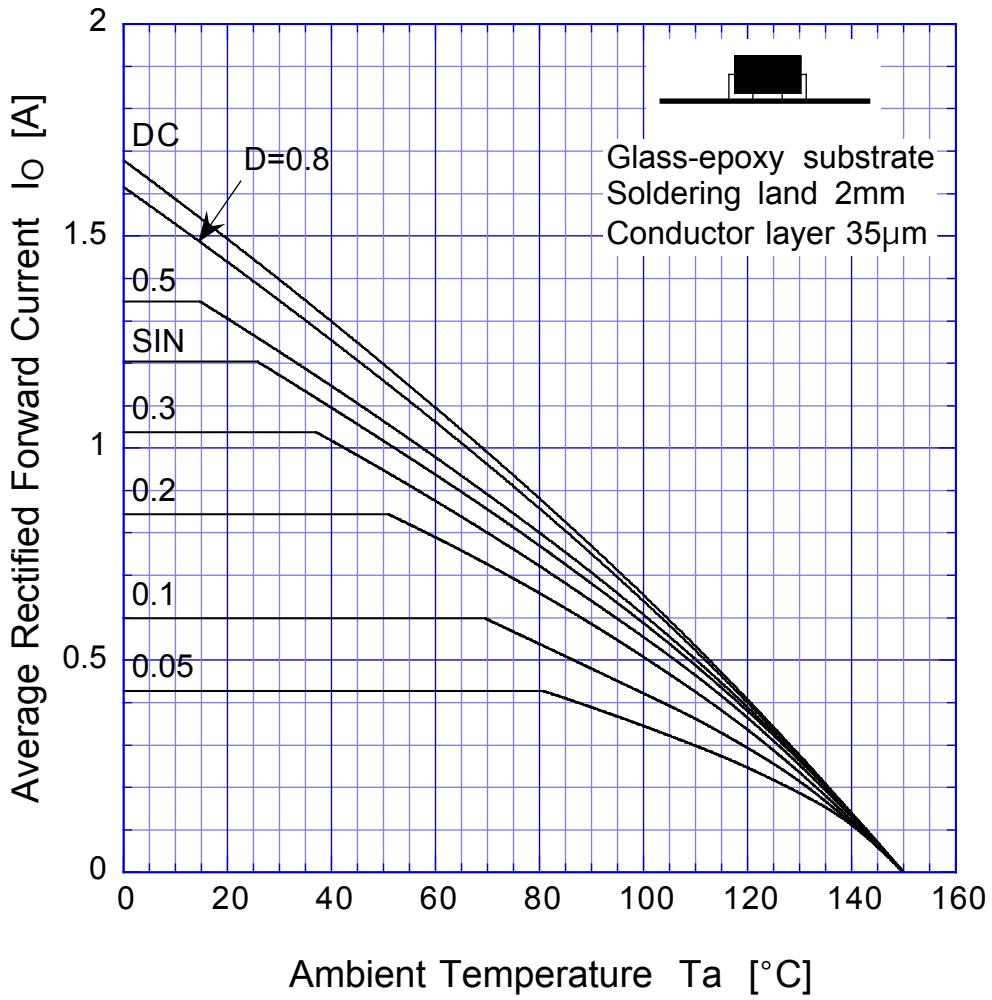

$$V_R = V_{RM}$$



D2FL20U

Peak Surge Forward Capability

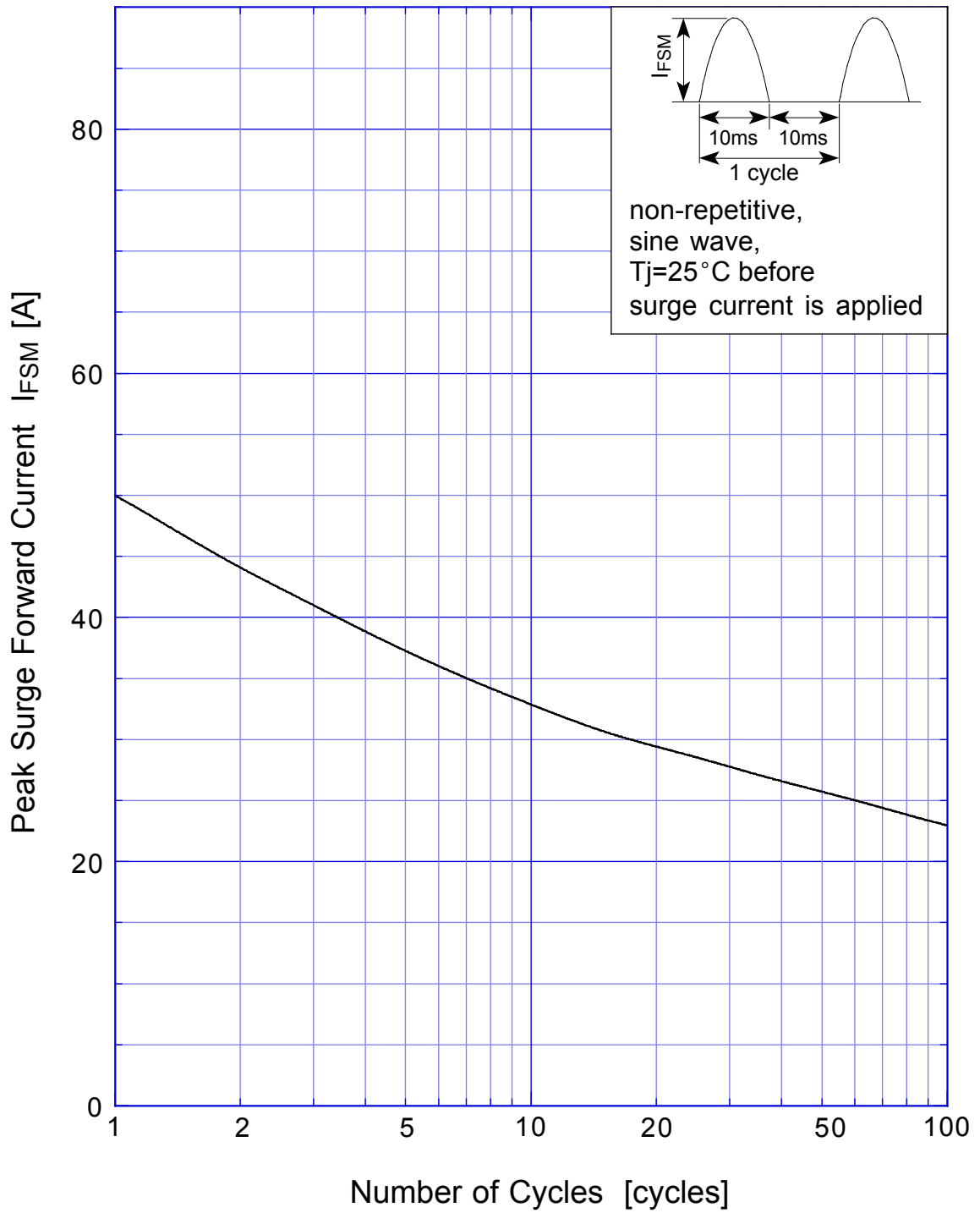

D2FL20U Junction Capacitance

